

DH-IPC-HFW4239T-ASE

2MP WDR Full-color Starlight Mini Bullet Network Camera



FULL-Color

System Overview

With upgraded H.265 encoding technology, Eco-savvy series brings high efficient video compression capability. It can save bandwidth and storage. Meanwhile, the series features starlight, full-color starlight, smart IR technology and intelligent image analysis techniques. This series supports reminder function, meanwhile fully protected from dust and water, certified to IP67 and vandal resistant to IK10 standard.

Functions

Full-color Starlight

With the adoption of high performance sensor and large-sized aperture lens, the camera is able to provide a more colorful image even under lowlight environment. Full-color starlight cameras are perfect for applications of low-light conditions which is over 1 lux, such as parking lots, urban streets, schools, museums, etc.

*Full-color starlight cameras can not work in total darkness environment.

ePoE technology

The ePoE technology of Dahua, designed internally, adopts advanced 2D-PAM3 coding modulation from physical layer, and realizes full duplex transmission over 800 meters at the speed of 10Mbps, or 300 meters at the speed of 100Mbps via Cat 5 or coaxial cable media. Besides, it supports PoE and PoC power supply technology which has greatly simplified construction and wiring. Dahua ePoE technology offer a new way to accomplish long distance transmission between IP camera and network switch. It allows more flexible surveillance system design, improves reliability and saves construction and wiring cost.

Wide Dynamic Range(WDR)

The camera achieves vivid images, even in the most intense contrast lighting conditions, using industry-leading wide dynamic range (WDR) technology. For applications with both bright and low lighting conditions that change quickly, true WDR (120 dB) optimizes both the bright and dark areas of a scene at the same time to provide usable video.

- 1/2.8" 2Megapixel progressive scan STARVIS™ CMOS
- H. 265&H.264 triple-stream encoding
- 25/30fps@1080P(1920×1080)
- Smart Detection supported
- WDR(120dB), Day/Night(Electronic), 3DNR, AWB, AGC, BLC
- Multiple network monitoring: Web viewer, CMS(DSS/PSS) & DMSS
- 3.6mm fixed lens (6mm optional)
- 1/1 Alarm in/out, 1/1 audio in/out
- Micro SD Memory,IP67,IK10, PoE



Intelligent Video System (IVS)

IVS is a built-in video analytic algorithm that delivers intelligent functions to monitor a scene for Tripwire violations, intrusion detection, and abandoned or missing objects. A camera with IVS quickly and accurately responds to monitoring events in a specific area. In addition to scene analytics, the camera supports face detection to quickly capture a face and upload the image to a server. The camera also offers tamper detection by recognizing a dramatic scene change and generating a warning message to inspect the camera.

Environmental

Dahua cameras operate in extreme temperature environments, rated for use in temperatures from -30° C to +60° C (-22° F to +140° F) with 95% humidity, allowing the camera to operate in the harshest environments.

Protection(IP67, wide voltage)

The camera allows for ±30% input voltage tolerance, suitable for the most unstable conditions for outdoor applications. Its 4KV lightning rating provides effective protection for both the camera and its structure against lightning. Subjected and certified to rigorous dust and immersion tests (IP67), the camera is the choice for installation in even the most unforgiving environments.

Smart H.265+

Smart H.265+ is the optimized implementation of the H.265 codec that uses a scene-adaptive encoding strategy, dynamic GOP, dynamic ROI, flexible multi-frame reference structure and intelligent noise reduction to deliver high-quality video without straining the network. Smart H.265+ technology reduces bit rate and storage requirements by up to 70% when compared to standard H.265 video compression.

Technical Specification

Camera

Image Sensor	1/2.8" 2Megapixel progressive scan CMOS
Effective Pixels	1920(H) x 1080(V)
RAM/ROM	256MB/32MB
Scanning System	Progressive
Electronic Shutter Speed	Auto/Manual, 1/3~1/100000s
Minimum Illumination	0.001Lux/F1.0 (Color,1/3s,30IRE) 0.006Lux/F1.0 (Color,1/30s,30IRE)
S/N Ratio	More than 50dB
IR LEDs	N/A

Lens

Lens Type	Fixed				
Mount Type	Board-in				
Focal Length	3.6mm (6mm optional)				
Max. Aperture	F1.0(F1.0)				
Angle of View	H: 87°/54°, V:47°/20°				
Focus Control	Fixed				
Close Focus Distance	1.6m(5.3ft)/3.5m (11.5ft)				
DORI Distance	Lens	Detect	Observe	Recognize	Identify
	3.6 mm	53m(174ft)	21m(69ft)	11m(36ft)	5m(16ft)
	6.0 mm	83m(289ft)	33m(108ft)	17m(56ft)	8m(26ft)

Pan/Tilt/Rotation

Pan/Tilt/Rotation Range	Pan:0°~360°; Tilt:0°~90°; Rotation:0°~360°
-------------------------	--

Intelligence

Event Trigger	Motion detection, Video tampering , Scene changing, Network disconnection , IP address conflict, Illegal Access,Storage anomaly
IVS	Tripwire, Intrusion, Object Abandoned/Missing
Advanced Intelligent Functions	Face Detection

Video

Compression	H.265/H.264/H.264B/H.264H/MJPEG(Sub Stream)
Smart Codec	Support H.265+/H.264+
Streaming Capability	3 Streams
Resolution	1080P(1920x1080)/1.3M(1280x960)/720P(1280x720)/D1(704x576/704x480)/VGA(640x480)/CIF(352x288/352x240)
Frame Rate	Main Stream: 1080P (1~25/30fps)
	Sub Stream: D1(1~25/30fps)
	Third Stream: 1080P(1~25/30fps)
Bit Rate Control	CBR/VBR
Bit Rate	H.264: 24K ~ 10240Kbps H.265: 14K ~ 9984Kbps
Day/Night	Color(default) /Auto(Electronic) / B/W
BLC Mode	BLC / HLC / WDR(120dB)

White Balance	Auto/Natural/Street Lamp/Outdoor/Manual
Gain Control	Auto/Manual
Noise Reduction	3D DNR
Motion Detetion	Off / On (4 Zone, Rectangle)
Region of Interest	Off / On (4 Zone)
Electronic Image Stabilization (EIS)	N/A
Smart IR	Support
Defog	N/A
Digital Zoom	16x
Flip	0°/90°/180°/270°
Mirror	Off / On
Privacy Masking	Off / On (4 Area, Rectangle)

Audio

Compression	G.711a/ G.711Mu/ AAC/ G.726
-------------	-----------------------------

Network

Ethernet	RJ-45 (10/100Base-T)
Protocol	HTTP;HTTPS;TCP;ARP;RTSP;RTP;RTCP;UDP;PPPOE;IEEE802.1X;SMTP;SNMP;FTP;DHCP;DNS;DDNS;PPPoE;IPV4/V6;QoS;UPnP;NTP;Bonjour;IEEE 802.1X;Multicast;ICMP;IGMP;TLS;SSH;NFS
Interoperability	ONVIF Profile S&G, API
Streaming Method	Unicast / Multicast
Max. User Access	10 Users /20 Users
Edge Storage	NAS Local PC for instant recording Mirco SD card 128GB
Web Viewer	IE, Chrome, Firefox, Safari
Management Software	Smart PSS, DSS, DMSS
Smart Phone	IOS, Android

Certifications

Certifications	CE (EN 60950:2000) UL:UL60950-1 FCC: FCC Part 15 Subpart B
----------------	--

Interface

Video Interface	N/A
Audio Interface	1/1 channel In/Out
RS485	N/A
Alarm	1 channel In: 5mA 5VDC 1 channel Out: 300mA 12VDC

Electrical

Power Supply	DC12V, PoE (802.3af)(Class 0)
Power Consumption	<4W

Environmental

Operating Conditions	-30° C ~ +60° C (-22° F ~ +140° F) / Less than 95% RH
Storage Conditions	-30° C ~ +60° C (-22° F ~ +140° F) / Less than 95% RH
Ingress Protection	IP67
Vandal Resistance	IK10

Construction

Casing	Metal
Dimensions	244.1mm×79mm×75.9mm (9.61"×3.11"×2.99")
Net Weight	0.815kg (1.80lb)
Gross Weight	1.08kg (2.38lb)

Ordering Information

Type	Part Number	Description
2MP camera	DH-IPC-HFW4239TP-ASE	2MP Full-color Starlight Mini Bullet Network Camera, WDR, PAL
	DH-IPC-HFW4239TN-ASE	2MP Full-color Starlight Mini Bullet Network Camera, WDR, NTSC
	HFW4239TP-ASE	2MP Full-color Starlight Mini Bullet Network Camera, WDR, PAL
	HFW4239TN-ASE	2MP Full-color Starlight Mini Bullet Network Camera, WDR, NTSC
Accessories (optional)	PFA135	Junction box
	PFA152-E	Pole Mount
	LR1002	ePoE Over Coax Converter

Accessories

Optional:



PFA135 Junction Box



PFA152-E Pole Mount



LR1002 ePoE Over Coax Converter

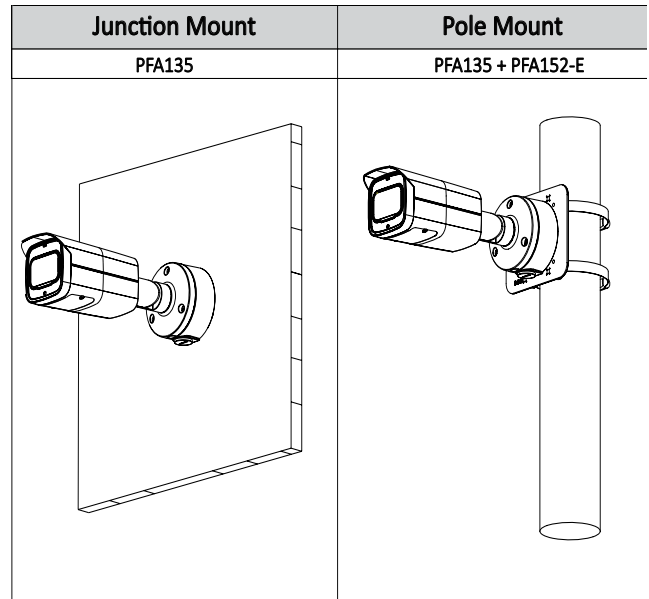

Dimensions (mm/inch)

